

ANTI-SUCTION MAIN DRAINS POOL FITTINGS & CLEANERS

Features:

- Curved surface design, anti-suction.
- UV-resistant, corrosion resistant, not easy to fade, longer life time.
- Meets various flow rate requirements.

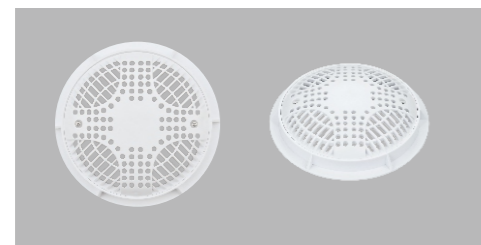
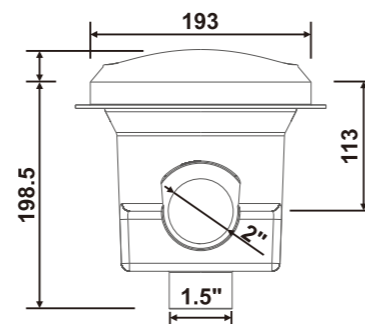
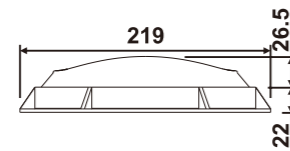
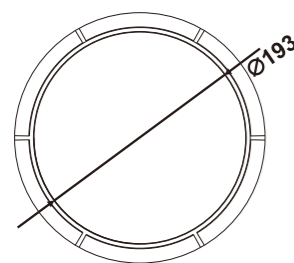

WL-JDP200AL

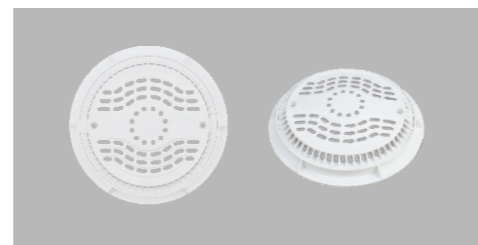

WL-JDP200BL



WL-JDP200AH



WL-JDP200BH

Model	Specification	Outlet	Cover Dia. (mm)	Height	Material	Max Flow Rate (m ³ /h)
WL-JDP200AL	cover + frame	—	193	22	ABS	33.5
WL-JDP200AH	cover+ body	side 2 bottom 1.5"	193	198.5	ABS	33.5
WL-JDP200BL	cover + frame	—	193	22	ABS	33.5
WL-JDP200BH	cover+ body	side 2 bottom 1.5"	193	198.5	ABS	33.5

ANTI-SUCTION MAIN DRAINS POOL FITTINGS & CLEANERS

Features:

- Curved surface design, anti-suction.
- Manufactured from UV- resistant engineered polymers.
- Used in new construction or to retrofit into existing Laswim frames.
- Meets various flow rate requirements.



WL-FDP9"

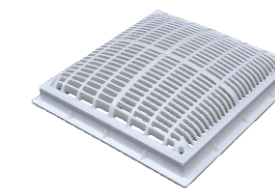
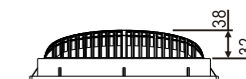
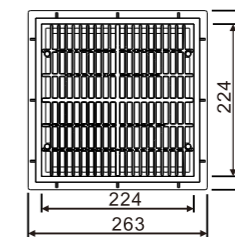

WL-FDP12"

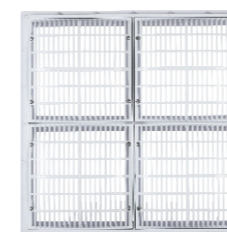
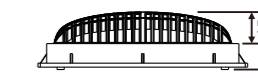
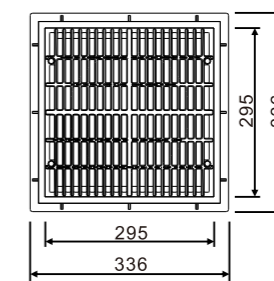

WL-FDP18"

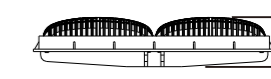
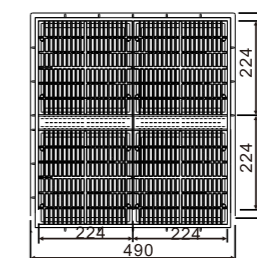

Model	Size (inch/ mm)	Thickness (mm)	Material	Design Flow (m ³ /h)
WL-FDP9"	9" x 9" 263mm x 263mm	70	ABS	23
WL-FDP12"	12" x 12" 336mm x 336mm	78	ABS	88
WL-FDP18"	18" x 18" 490mm x 490mm	100	ABS	93

GUTTER GRATINGS

POOL FITTINGS & CLEANERS

Gutter grating is molded in white UV resistant ABS. Top of grating features an anti-slip finish and it is composed of individual units connecting along a central spine. This design allows for easier installation without the need for cutting also allowing the grating to curve as necessary.

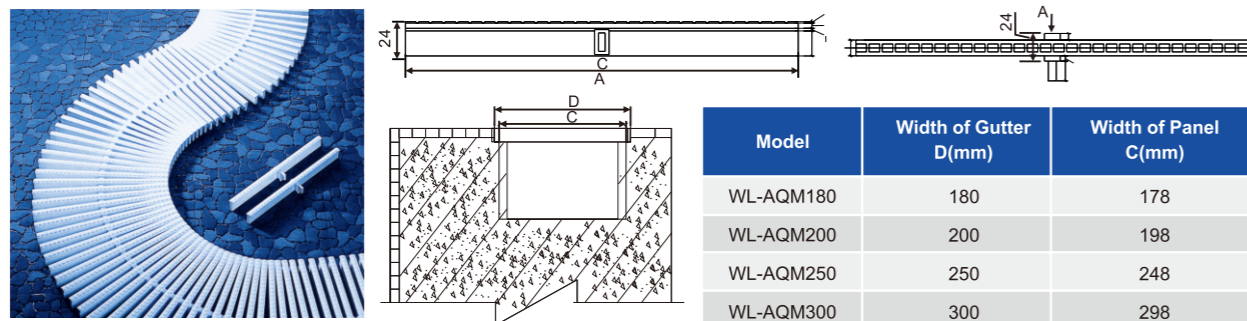

Model	Width of Gutter D(mm)	Width of Panel C(mm)
WL-AQM180	180	178
WL-AQM200	200	198
WL-AQM250	250	248
WL-AQM300	300	298

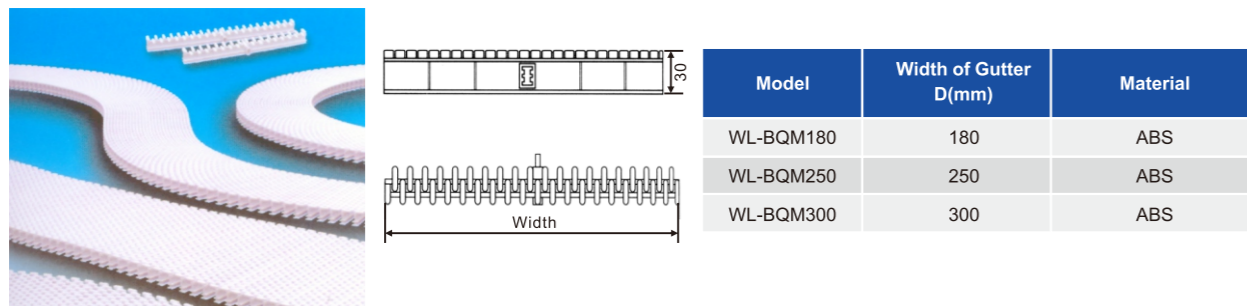

Model	Width of Gutter D(mm)	Material
WL-BQM180	180	ABS
WL-BQM250	250	ABS
WL-BQM300	300	ABS

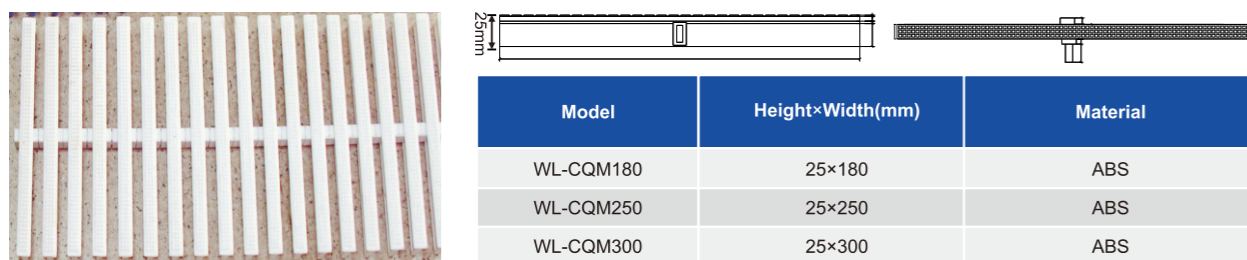

Model	Height×Width(mm)	Material
WL-CQM180	25×180	ABS
WL-CQM250	25×250	ABS
WL-CQM300	25×300	ABS

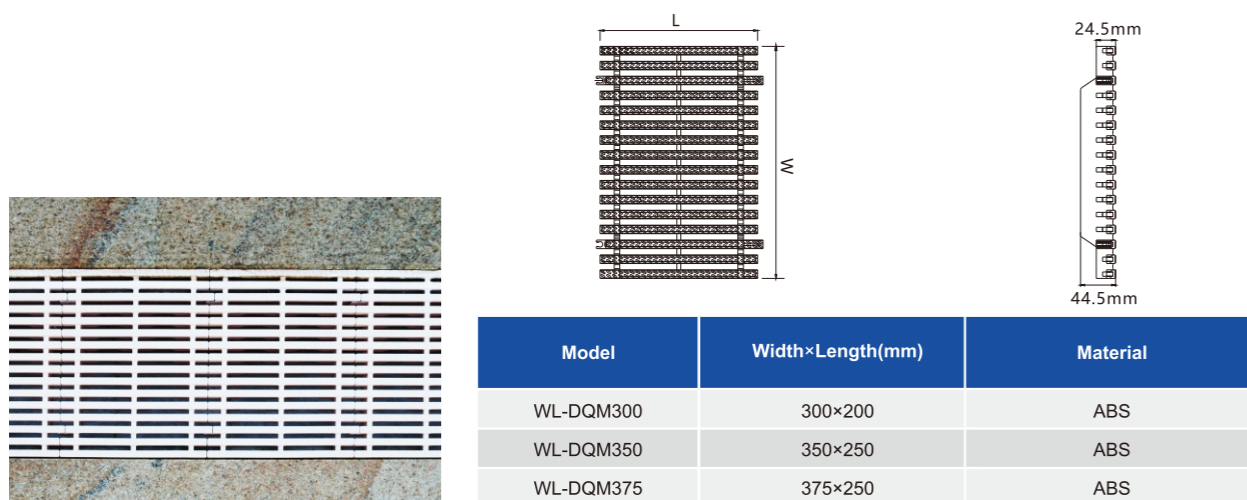

Model	Width×Length(mm)	Material
WL-DQM300	300×200	ABS
WL-DQM350	350×250	ABS
WL-DQM375	375×250	ABS

GUTTER GRATINGS

POOL FITTINGS & CLEANERS

Features:

- Comply with the standard of EN-13451 and CJJ122-2008.
- Anti-slip, safe, super strong, durable.
- UV-resistant, not easy to fade or break, longer using life.
- To be easy to install and flexible to meet a variety of different swimming pool specifications.
- Composed of Part A and Part B as below drawing, Length is adjustable.
- Can make an arc with minimum radius of 625mm.

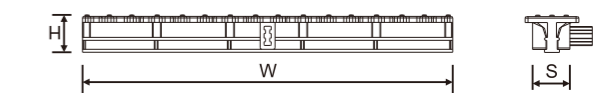
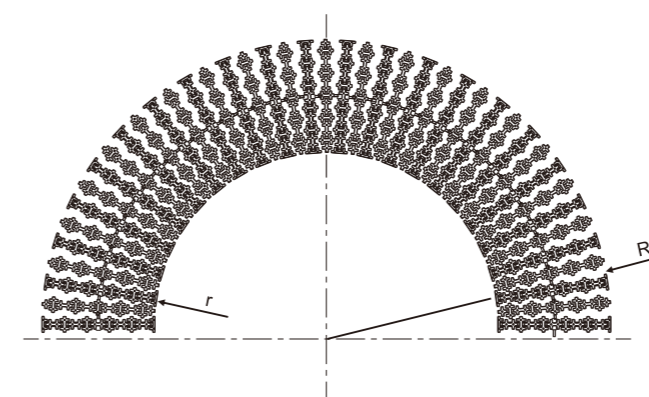
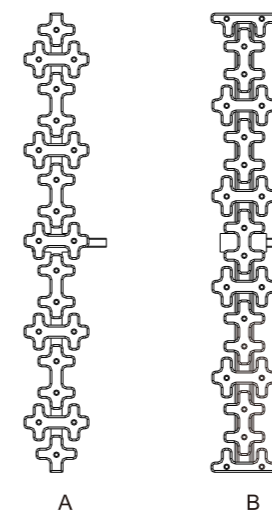
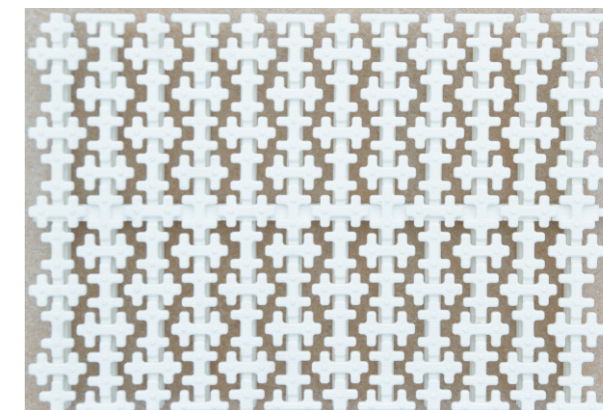

Model	W(mm)	S(mm)	H(mm)	R(mm)	r(mm)
WL-HQM250	250	29	25	625	375

SAFETY CHECK VALVE

POOL FITTINGS & CLEANERS

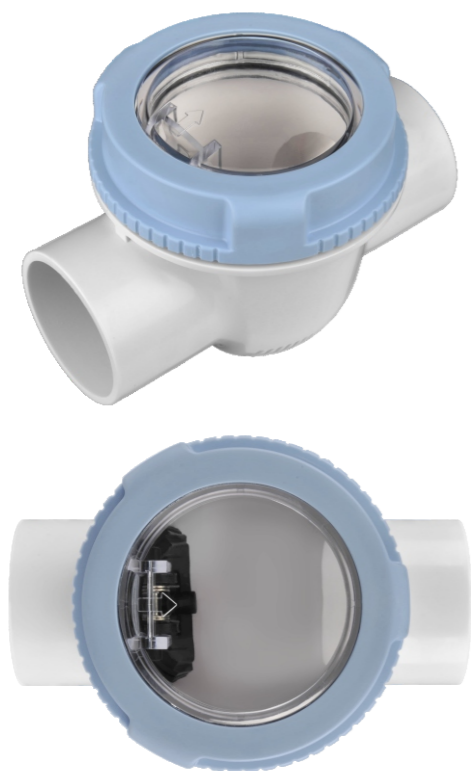

WL-DZF50A/B

Safety check valve is an essential accessory for circulating pumps. Its main function is to avoid damaging the impeller when pump stops working.

LASWIM safety check valve is specially designed for swimming pool and spa and it relies on the flow of the liquid itself to turn on and turn off the seal baffle automatically, then form the directional flow of the liquid. It ensures the directional flow of water from swimming pool and spa and prevents water from backflow.

Features:

- Transparent lid, convenient to watch flow direction of water.
- Seal baffle and stainless steel spring with numerous tests ensure high performance and reliable quality.
- Being made of high quality engineering plastics, our Safety check valve is in high temperature resistance and corrosion resistance, which can adapt to acidic or alkaline fluid in temperature 5-50°C.
- Safety check valve in metric or imperial is optional, facilitating the installation.

DZF series Safety Check Valve has two models: model A and model B, model A :2" model B :Φ63mm

Model	A	B	C	D
DZF50-A	Φ2"	139	190	Φ134
DZF50-B	Φ63	139	190	Φ134

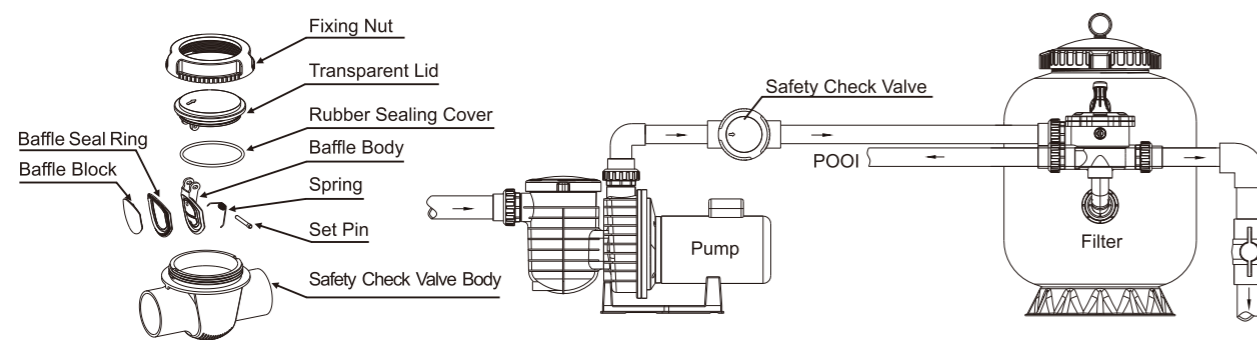
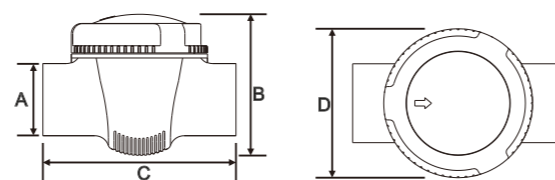

WL-DZF Series Exploded Drawing And Installation Diagram

LADDERS

POOL FITTINGS & CLEANERS

1. Grab Rails and Anchor Sockets

Closed rail design and constructed with polished Stainless Steel and Anchor Socket .

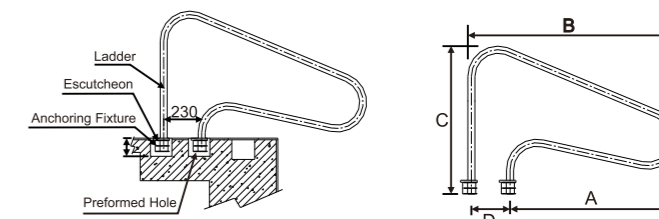
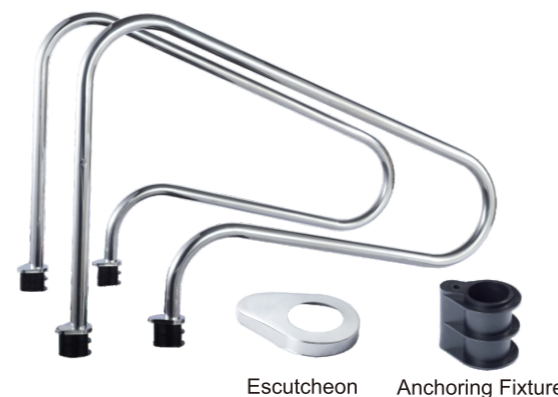

Model	A (mm)	B (mm)	C (mm)	D (mm)	Specification
WL-SRG	1000	1250	880	230	Φ42

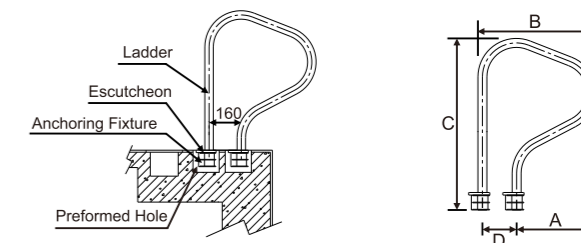

Model	A (mm)	B (mm)	C (mm)	D (mm)	Specification
WL-SRB	375	555	805	160	Φ42

2.Ladder For Overflow Pool

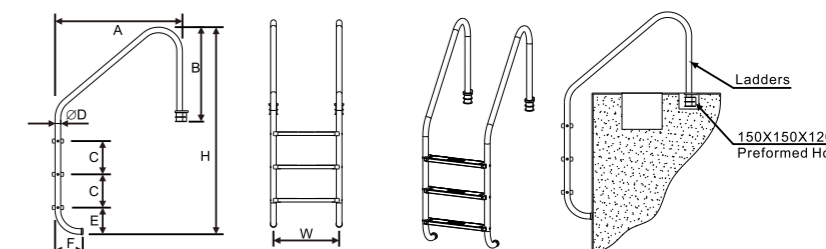

Model	A (mm)	B (mm)	C (mm)	∅D (mm)	E (mm)	F (mm)	H (mm)	W (mm)
WL-KFT202	957	710	250	42	200	208	1306	500
WL-KFT203	957	710	250	42	200	208	1556	500
WL-KFT204	957	710	250	42	200	208	1806	500
WL-KFT205	957	710	250	42	200	208	2056	500

LADDERS POOL FITTINGS & CLEANERS

3. Ladders for embedded pools. Handrails in hand polished stainless steel pipe. Steps in stainless steel and anti-slip. Complete with anchoring fixtures and earth connection. Easy installation (with diameter 42mm) .



Anti-Slip Steps

Anti-Slip Steps

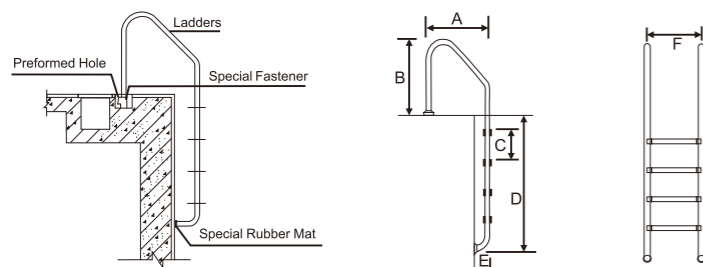

Model	A(mm)	B(mm)	C(mm)	D(mm)	E(mm)	F(mm)	Specification
WL-SL202	592	700	250	600	180	500	Ø42
WL-SL203	592	700	250	850	180	500	
WL-SL204	592	700	250	1100	180	500	
WL-SL205	592	700	250	1350	180	500	

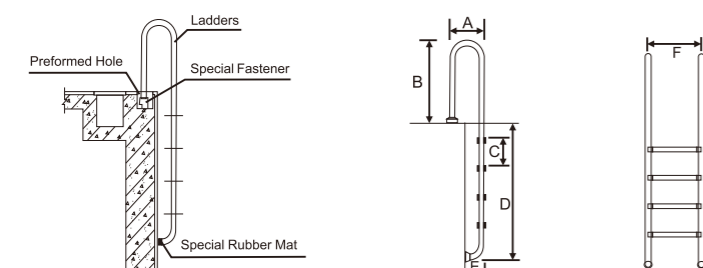

Model	A(mm)	B(mm)	C(mm)	D(mm)	E(mm)	F(mm)	Specification
WL-MC202	314	700	250	600	180	500	Ø42
WL-MC203	314	700	250	850	180	500	
WL-MC204	314	700	250	1100	180	500	
WL-MC205	314	700	250	1350	180	500	

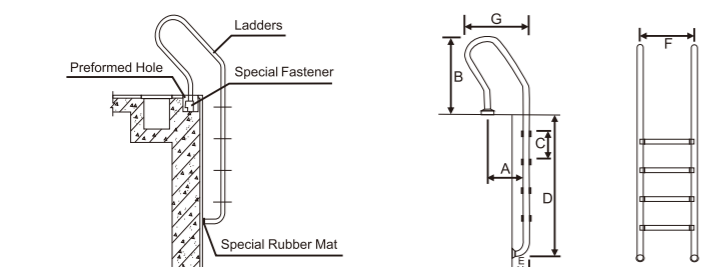

Model	A(mm)	B(mm)	C(mm)	D(mm)	E(mm)	F(mm)	G(mm)	Specification
WL-SF202	280	700	250	600	180	500	592	Ø42
WL-SF203	280	700	250	850	180	500	592	
WL-SF204	280	700	250	1100	180	500	592	
WL-SF205	280	700	250	1350	180	500	592	

POOL FITTINGS & CLEANERS

VACUUM HEADS & JET VACS

BRUSHES

CHEMICAL DISPENSERS & TEST KITS

--	--	--	--	--

POOL FITTINGS & CLEANERS

LEAF SKIMMERS

 Model: 1301 Standard leaf skimmer	 Model: 1302 Heavy duty Plastic leaf skimmer w/ long wearing mesh	 Model: 1303 Aluminum leaf skimmer (blue anodized handle)	 Model: 1305 Professional heavy duty aluminum leaf skimmer	 Model: 1306 Leaf skimmer with aluminum frame and plastic handle
 Model: 1201 Economy deep dag skimmer	 Model: 1202 Economy deep bag skimmer with aluminum handle	 Model: 1203 Aluminum frame deep rake (Blue anodized handle)	 Model: 1204 Heavy duty plastic leaf rake with long wearing mesh	 Model: 1205 Professional heavy duty deep rake w/aluminum frame
 Model: 1307 Leaf skimmer w/aluminum pole of 48"-122cm in 5 section	 Model: 1310 Leaf skimmer w/ 60"- 150cm aluminum pole	 Model: 1309 Leaf skimmer w/ 48"- 122cm aluminum pole	 Model: 1308 Leaf skimmer with 3X14"-35cm telescopic pole	

HOSE









Model	Description
WL-BXG01	Extruded PE. ϕ 1 1/2" - 7M
WL-BXG02	Extruded PE. ϕ 1 1/2" - 9M
WL-BXG04	Extruded PE. ϕ 1 1/2" - 13M
WL-BXG05	Extruded PE. ϕ 1 1/2" - 15M
WL-BXG06	Extruded PE. ϕ 1 1/2" - 30M
WL-BXG07	Extruded PE. ϕ 1 1/2" - 50M

Model	Description
3203	Vacuumhose ϕ 1/4" , 1m persection-36m
3803	Vacuumhose ϕ 1/2" , 1m persection-36m
3204	Vacuumhose ϕ 1/4" , 1m persection-50m
3804	Vacuumhose ϕ 1/2" , 1m persection-50m

Model	Description
3206	Spiralwound EVA. ϕ 11/4" -6M
3209	Spiralwound EVA. ϕ 11/4" -9M
3212	Spiralwound EVA. ϕ 11/4" -12M
3809	Spiralwound EVA. ϕ 11/2" -9M
3811	Spiralwound EVA. ϕ 11/2" -11M
3813	Spiralwound EVA. ϕ 11/2" -13M
3815	Spiralwound EVA. ϕ 11/2" -15M

Model	Description
2212	2X120 cm Ribbed pole-0.8mm thick
2224A	2X240 cm Ribbed pole-0.8mm thick
2312	3X120 cm Ribbed pole-0.8mm thick
2330A	3X300 cm Ribbed pole-0.8mm thick
2224B	2X240 cm Ribbed pole-1.1mm thick
2230	2X300 cm Ribbed pole-1.1mm thick
2330B	3X300 cm Ribbed pole-1.1mm thick

THERMOMETERS

 Model: 2908 Swivel Cuff for vacuum hose(1pc)	 Model: 1601 Economy thermometer	 Model: 1602 Large thermometer	 Model: 1603 Jim Buoy thermometer	 Model: 1605 Deluxe round thermometer
 Model: 1604 Deluxe floating thermometer with string attachment	 Model: 1607 Jumbo easy read thermometer	 Model: 1610 Floating animal thermometer in 4 styles	 Model: 1611 Floating cool pool animal thermometer in 3 styles	

FOUNTAINS & SPARE PARTS

 Model: 1708 Waterfall fountain	 Model: 1709 Flower waterfall fountain	 Model: 1725 Plastic pole hanger (2pcs) w/screws	 Model: 2902 Quick snap butterfly clips (4PCS)	 Model: 2021 Complete return inlet
 Model: 2901 Standard vacuum head handle	 Model: 2904 Replacement bag for Jet Vac head	 Model: 3861 Hose Reel-carries vacuum hose up to 13m in length	 Model: 1809 Automatic pool cleaner 10pcs*100 cm/pc hose included (standard)	 Model: 1811 Automatic pool cleaner 10pcs*100 cm/pc hose included (standard)
 Model: 2903 Long lock pin for vacuum handle (4PCS)	 Model: 2905 NPT tie-in for American standard (2PCS)	 Model: 2906 BSPT tie-in for European standard (2PCS)		

Model	Description
1717	Above ground pool cover reel w/ABS frame for ϕ 3-14" & 1-1/2" tubes(not include AL pole)
2321	Pole for 8341, 3'2.1m (hexagonal)
2327	Pole for 8341, 3'2.7m (hexagonal)
2335	Pole for 8341, 3'3.55m (hexagonal)

Model	Description
1718	Above ground pool Solar Reel System(not include AL pole)
2321	Pole for 8342, 3X2.1M
2324	Pole for 8342, 3X2.44M